

KENWOOD

DIGITAL AUDIO TAPE RECORDER

DX-7

INSTRUCTION MANUAL

KENWOOD CORPORATION

For your records

Record the serial number, found bottom of the unit in the spaces designated on the warranty card, and in the space provided below. Refer to the model and serial numbers whenever you call your dealer for information or service on this product.

Model DX-7 Serial number _____

Unpacking

Unpack the unit carefully and make sure that all accessories and cables are put aside so they will not be lost.

Examine the unit for any possibility of shipping damage. If your unit is damaged or fails to operate, notify your dealer immediately. If your unit was shipped to you directly, notify the shipping company without delay. Only the consignee (the person or company receiving the unit) can file a claim against the carrier for shipping damage.

We recommend that you retain the original carton and packing materials for use should you transport or ship the unit in the future.

Before applying power of AC adaptor

Important!

USA and Canada

Unit shipped to the above are not equipped with an AC voltage selector switch and the discussion of such a switch that follows should be disregarded.

All other countries

AC adaptor shipped to countries other than the above are equipped with an AC voltage selector switch on the top cover. Refer to the following paragraph for the proper setting of this switch.

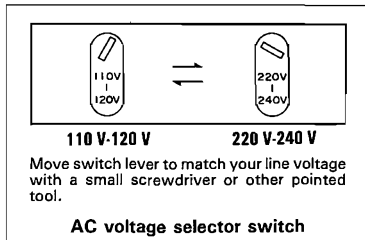

Fig. 1

Before plugging in this unit, make sure that the position of the AC Voltage Selector conforms to your line (mains) voltage. If not, it must be reset. See Fig. 1.

WARNING NOTICE:

IN MOST CASES IT IS AN INFRINGEMENT OF COPYRIGHT TO MAKE COPIES OF TAPES OR DISCS WITHOUT THE PERMISSION OF THE COPYRIGHT OWNERS. ANYONE WISHING TO COPY COMMERCIALY AVAILABLE TAPES OR DISCS SHOULD CONTACT THE MECHANICAL COPYRIGHT PROTECTION SOCIETY LIMITED OR THE PERFORMING RIGHTS SOCIETY LIMITED.

AC voltage selection

AC adaptor operates on 110~120 volts or 220~240 volts AC. Before connecting the power cord to your AC outlet, make sure that the setting position of this switch matches your line voltage. If not, it must be set to your voltage in accordance with the following direction.

Note:

Our warranty does not cover damage caused by excessive line voltage due to improper setting of the AC voltage selector switch.

WARNING:

TO PREVENT FIRE OR ELECTRIC SHOCK, DO NOT EXPOSE THIS APPLIANCE TO RAIN OR MOISTURE.

Precautions for use

To maintain the high performance and reliability of this unit, avoid using or storing it in the following conditions.



- Dusty places.



- Places exposed to direct sunlight, especially in a closed car.



- Near heat sources such as stoves, etc.



- Extremely cold places.

■ Condensation (dew)

- In moist, humid locations or when the room temperature rises quickly such as right after turning on a heater, condensation may form inside the unit, preventing the unit from operating normally. If this occurs, remove the tape and let the unit sit with the cassette holder open for approximately two hours before use.

(The entire display area blinks to warn you that there is condensation inside the unit.)

■ Using headphones

- DAT players have such a low noise level that listeners often tend to overly increase the sound volume. Set the sound volume to an appropriate level to protect your ears from excessive shock.
- For your safety and the safety of others, do not use headphones while driving a car or other type of vehicle.
- Be careful not to fall asleep while listening to music using headphones.
- Continuous use of headphones for long periods may hurt your ears.

Use of DAT cassette tapes

- Tapes cannot be turned over and played on the other side.
- Tapes are manufactured with a sealed construction. Do not try to forcefully open the tape cover or pull the tape from the case, and never attempt to disassemble the tape case.
- Do not repeatedly insert and remove a tape without playing or recording the tape. The tape may become slack or damaged.
- After use, completely rewind the tape and store it properly. The tape may be damaged if stored without being fully rewound.
- Always place a tape in its case for storing.

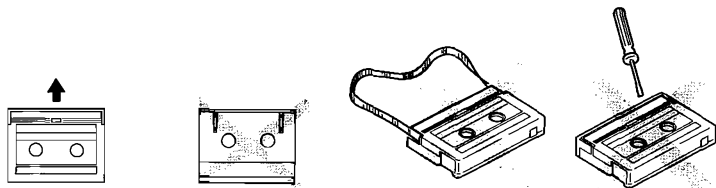

■ Accidental erasure prevention side door

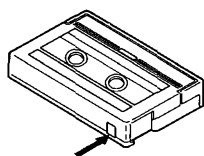

To prevent accidental erasure

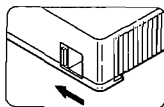

Re-recording

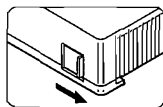

■ DAT tape recording system

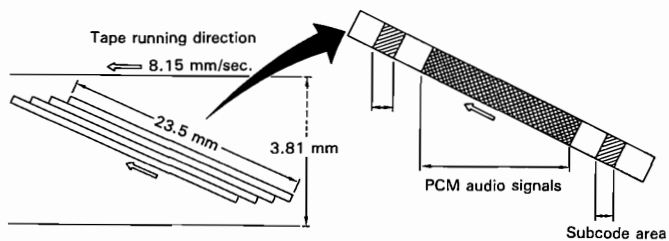

Controls, connectors and indicators

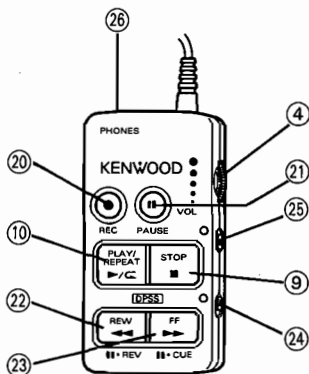
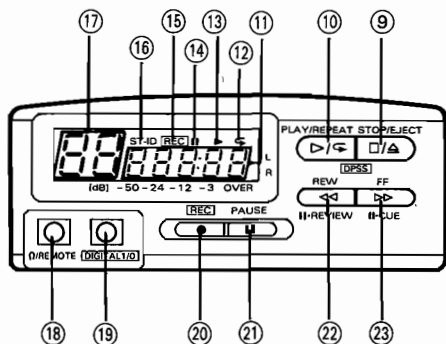
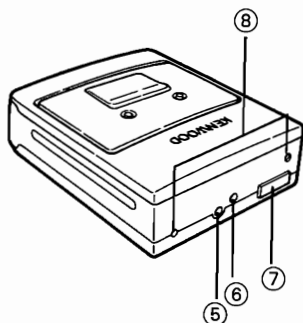
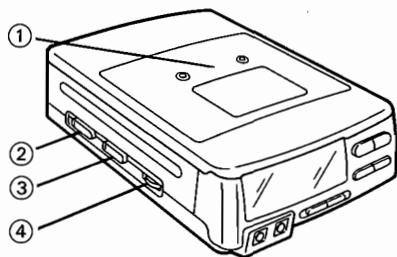

- | | |
|---|------------------------------------|
| ① Cassette holder | ⑭ [] Pause indicator |
| ② POWER switch | ⑮ [REC] Recording indicator |
| ③ KEY HOLD/TIMER switch | ⑯ [ST-ID] indicator |
| * ④ VOLUME control knob | ⑰ Tune number display |
| ⑤ DC IN jack | ⑱ PHONES/REMOTE jack |
| ⑥ Threaded hole for accessory attachment | ⑲ DIGITAL I/O jack |
| ⑦ System connection jack | * ⑳ REC (Record) button |
| ⑧ Accessory attachment guide hole | * ㉑ PAUSE button |
| ⑨ STOP/EJECT button | * ㉒ REWIND/REVIEW button |
| * ⑩ PLAY/REPEAT button | * ㉓ FF/CUE button |
| ⑪ Total elapsed time display | ㉔ HOLD switch |
| ⑫ [⏮] Repeat indicator | ㉕ REC HOLD switch |
| ⑬ [▶] Play indicator | ㉖ PHONES jack |

Keys marked with an asterisk “*” have the same function on both the main unit and the remote controller.

Power source

■ How to use the unit with the supplied AC adaptor

- Insert the plug of the AC adaptor into the [DC IN] jack on the main unit's rear panel, then connect the power plug to a household AC power outlet.
- Always set the [POWER] switch to OFF before connecting the AC adaptor. When disconnecting the AC adaptor as well, be sure to first turn the [POWER] switch OFF. (Not doing so may damage the tape or rotating heads.)

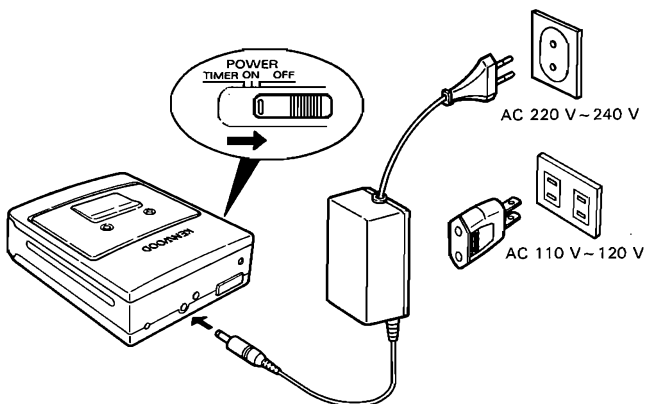

■ Using a car cigarette lighter

Use the separately sold DC-C5 car battery adaptor.

- Turn the [POWER] switch OFF before connecting. Also, be sure to set the [POWER] switch to OFF before turning the car's ignition key OFF.

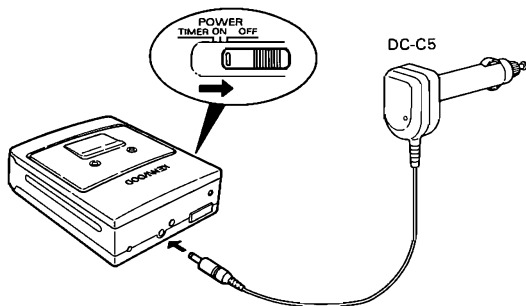

■ Using rechargeable batteries

Use the separately sold A/D converter (BP-A7).

- Align the A/D converter with the main unit's accessory attachment guide hole and attach. Secure the A/D converter in place using the accessory attachment screw.
- Always turn the [POWER] switch OFF before inserting/removing batteries or making connections.
- Paying close attention to match the insertion direction with the arrows, insert two NB-8 rechargeable battery packs (supplied in the BP-A7 kit) into the A/D converter/battery pack unit supplied in the BP-A7 kit.

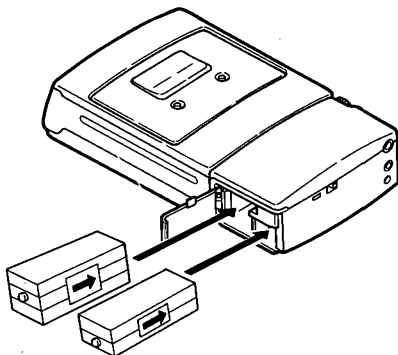

- **Recharging period:**

When the batteries run down, "Lo" appears in the display area to indicate that operation will soon stop. Recharge the batteries at this time for continued operation.

- **For maximum battery life:**

One characteristic of Ni-Cd batteries is that their battery life becomes shorter if they are repeatedly recharged before being completely used up. If this occurs, battery life can be returned to normal by repeatedly letting the batteries completely run down before recharging.

Connections

■ Headphone connection

- Connect separately sold headphones (use headphones equipped with a 3.5 mm diameter stereo miniplug) to the main unit's [ /REMOTE] jack or the remote controller's [PHONES] jack.
- Always turn the volume down before plugging or unplugging the headphones.

• Sound volume adjustment

Adjustment using the main unit:

Set the remote controller's [VOL] control to maximum and adjust the volume using the main unit's [VOLUME] control.

Adjustment using the remote controller:

Set the main unit's [VOLUME] control to about "8" and adjust the volume using the remote controller's [VOL] control.

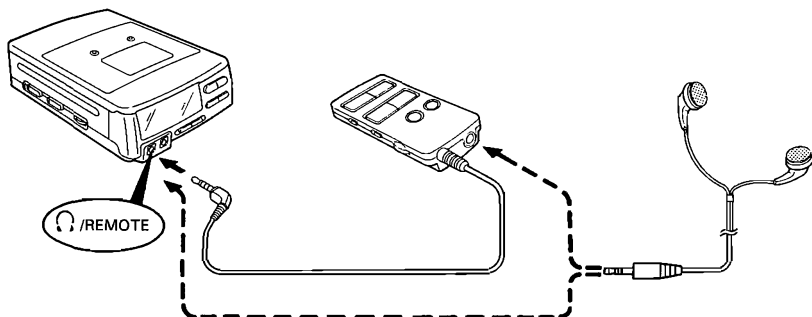

■ Connection to a car stereo

Use the separately sold Car Audio Cassette adaptor (CAC-1).

Insert the plug of the CAC-1 into the main unit's [ /REMOTE] jack or the remote controller's [PHONES] jack.

- Adjust the sound volume using the car stereo's volume control.
Set the main unit's [VOLUME] control to about "8" and set the remote controller's [VOL] control to maximum.

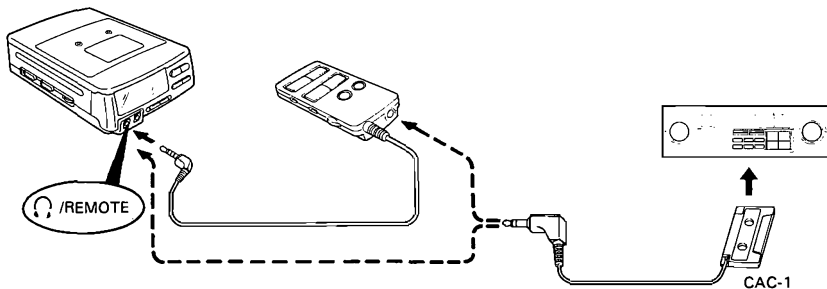

■ Connection to a component equipped with digital I/O jacks (coaxial)

- Turn off the power to both the amplifier and this unit before making connections.
- Using the supplied digital connection cord, connect the 4-pin miniplug to this unit's [DIGITAL I/O] terminal.
- Connect the red plug to the component's (amplifier, etc.) coaxial input jack and connect the white plug to the coaxial output jack.
- Make sure the plugs are inserted securely. Improper connection may cause sound dropouts or noise.
- Connection to optical digital jacks is not possible.

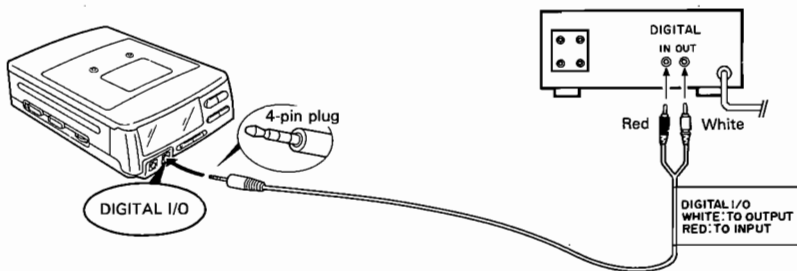

■ Connection to a portable CD player equipped with a digital output jack

- When connecting to a portable CD player (such as the DPC-90) equipped with a digital output jack, use the supplied digital-use adaptor plug.

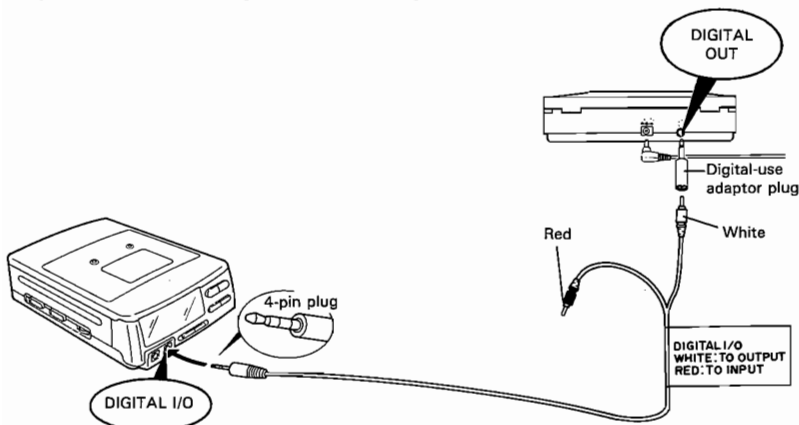

■ Connection to an amplifier's analog input jacks

- Turn off the power to both the amplifier and this unit before making connections.
- Using the supplied analog connection cord, connect the 3-pin miniplug to this unit's [ / REMOTE] terminal.
Connect the other end of the cord to the amplifier's external input jacks (AUX jacks, TAPE PLAY jacks, etc.).
Connect the red plug to the "R" (right channel) input jack and the white plug to the "L" (left channel) input jack.
- **Sound volume adjustment:**
Set the main unit's [VOLUME] control to about "8".
When connecting to the supplied remote controller, turn the remote controller's [VOL] control to maximum.
Adjust the sound volume using the amplifier's volume control.

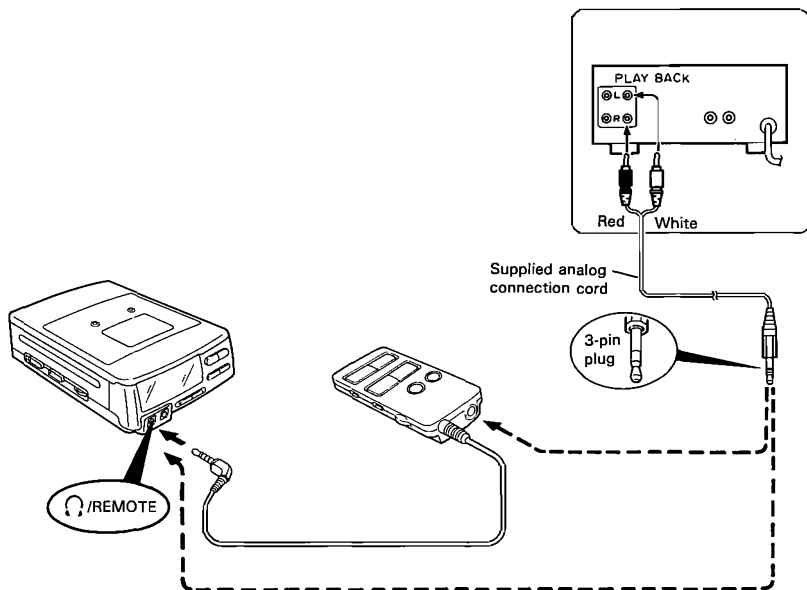

■ Connection for analog recording

Use the separately sold A/D converter (BP-A7).

- Turn off the power to both the amplifier and this unit before making connections.
- Connect the A/D converter unit (supplied in the BP-A7) to this unit.
- Connect the A/D converter unit's [MIC/LINE IN] jack to an amplifier's [TAPE REC] jacks or a stereo microphone.
- Connect the A/D converter unit's [LINE OUT] jack to an amplifier's external input jacks (AUX jacks, TAPE PLAY jacks, etc.).

Both input and output connections should be made with the red plug connected to the amplifier's "R" (right channel) jack and the white plug connected to the "L" (left channel) jack.

- Use the A/D converter unit's [MIC/LINE] switch to MIC or LINE, depending on the connection.
- Adjust the playback sound volume using the amplifier's volume control.
- When using a microphone, use a stereo microphone equipped with a 3.5 mm diameter stereo miniplug. If you use a monaural microphone, the sound will be recorded on the left channel only.

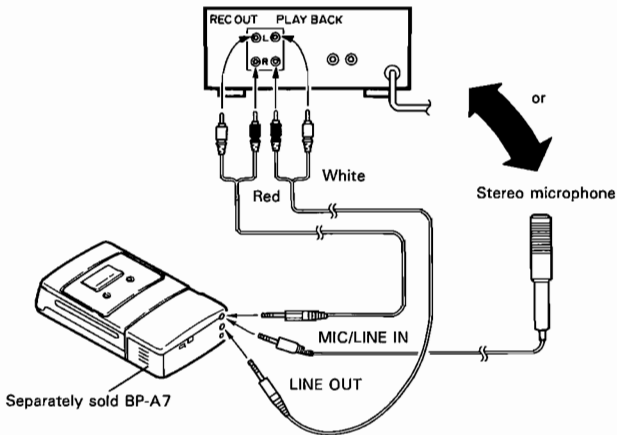

Key Hold function

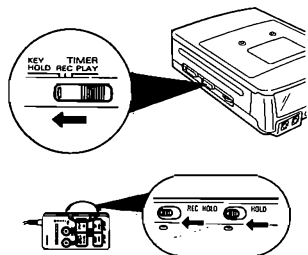

Setting this function prevents incorrect operation of the unit even if an operation button is accidentally pressed.

- When you set the main unit's [KEY HOLD/TIMER] switch to "HOLD", the unit ignores any button operation.
- When you set the remote controller's [HOLD] switch to the "●" position (so that the white indicator appears), operation of any of the remote controller's buttons is ignored.
- When you set the remote controller's [REC HOLD] switch to the "●" position (so that the white indicator appears), operation of the remote controller's [REC] button is ignored.

Inserting a tape

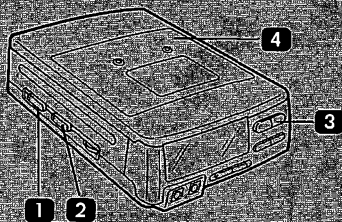

- A tape cannot be inserted when the power is off.
 - 1 Set the [POWER] switch to "ON".
 - 2 Set the [KEY HOLD/TIMER] switch to "HOLD".
 - 3 Press the [STOP/EJECT] button. "OPEN" appears on the display and the cassette holder opens.
 - 4 Insert a tape into the cassette holder.
- Press the cassette holder closed until it locks. After a tape is loaded, the unit enters stop mode.
- To remove the tape, press the [STOP/EJECT] button again.

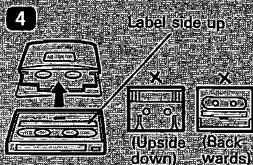

- Auto Power Off function:
If 10 minutes elapse with the unit in stop mode, the power automatically turns off. To turn the power back on, turn the [POWER] switch OFF and then ON again.

To playback a DAT cassette (Basic operation)

First load a tape into the unit (see page 14).

Operation is possible with either the main unit or the remote controller.

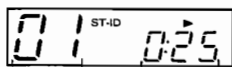
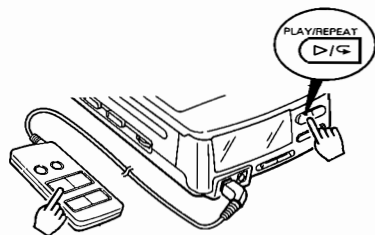

Tune number display

Total elapsed time display

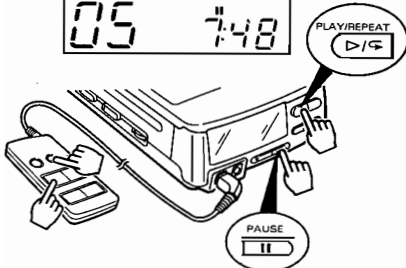
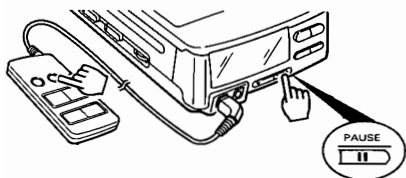
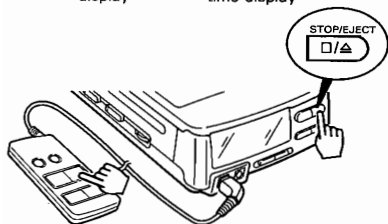

■ To play a tape

- Press the [PLAY/REPEAT] button.
- Tapes recorded in extended play mode cannot be played.
If you attempt to play such a tape, "NO PLAY" appears on the display.
- If the playback position is in the middle of a tune when the tape is loaded, the tune number for that tune will not be displayed. Tune numbers will be displayed from the beginning of the next tune.

■ To stop playback

- Press the [STOP/EJECT] button.
- To resume playback, press the [PLAY/REPEAT] button again.

When finished, remove the tape from the unit and set the [POWER] switch to OFF.

■ To pause playback

- Press the [PAUSE] button.
- To resume playback, press the [PAUSE] button again or press the [PLAY/REPEAT] button.
- If five minutes elapse with the unit in pause mode, the unit automatically enters stop mode.

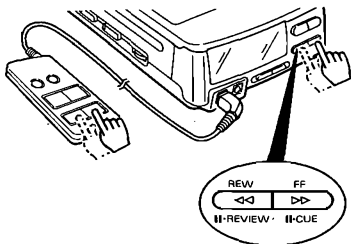

■ To fast-forward or rewind the tape

- In stop mode, press the [FF/CUE] button to fast-forward the tape and press the [REW/REVIEW] button to rewind the tape.
- Auto Rewind function:
When the last tune on the tape finishes playing, the tape automatically rewinds to the beginning and then stops.
The same operation occurs even if an END-ID is recorded. (See page 23.)

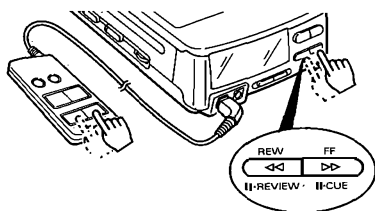

■ To skip to a desired tune (DPSS function)

By pressing the [FF/CUE] or [REW/REVIEW] button one or more times, you can skip to a subsequent or previous tune corresponding to the number of presses.

- During playback, pressing the [FF/CUE] button once skips to the beginning of the next tune.
- During playback, pressing the [REW/REVIEW] button once skips to the beginning of the current tune.

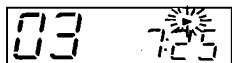

Display example

When the tape is stopped at the beginning

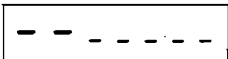

When the tape is stopped at the end

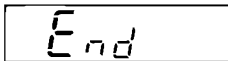

- When the beginning of the displayed tune is reached, "▶" appears on the display and playback begins.
- If the [PAUSE] button is pressed during the skip operation, the unit enters pause mode at the beginning of the designated tune.

The unit skips to a designated tune by searching for the tune's ST-ID recorded in the subcode area. If the ST-ID is not recorded on the tape, therefore, skipping cannot be carried out.

If pressed again while the "▶" indicator is blinking, the unit skips to a tune located even further in the skip direction.

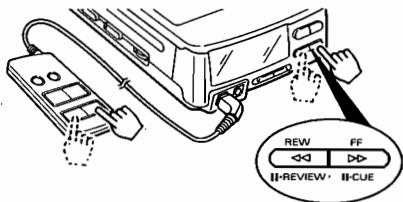

■ Cue/Review function

This function allows you to fast-forward (cue) or rewind (review) while listening to the tape sound.

- To cue, press the [PAUSE] button and then press the [FF/CUE] button.
- To review, press the [PAUSE] button and then press the [REW/REVIEW] button.
- When you reach the location you want to listen to, press the [PLAY/REPEAT] button.

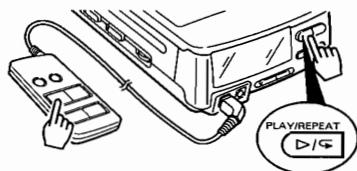
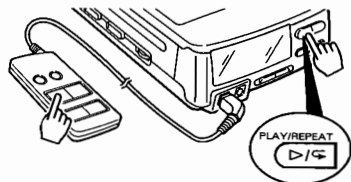

■ Repeat play

This function repeatedly plays the entire tape from the first tune to the last.

- During playback, press the [PLAY/REPEAT] button again. When the last tune finishes playing or when an END-ID is found, the tape automatically rewinds to the beginning and playback starts again from the first tune. The tape is repeated a maximum of 10 times until the [STOP/EJECT] button is pressed.
- To stop repeat playback: Press the [PLAY/REPEAT] button again so that the "↺" indicator goes out, or press the [STOP/EJECT] button to stop the tape.

Digital recording

First load a tape into the unit (see page 14).

Operation is possible with either the main unit or the remote controller.

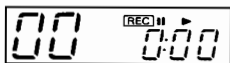
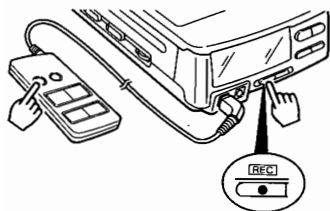

Connect the unit (See page 11.)

- Press the [REC] button.
When starting recording from the beginning of the tape, the unit automatically creates a 5-second blank section and then enters record-standby mode.
- Press the [PLAY/REPEAT] button to start recording.
You can also start recording by pressing the [PAUSE] button.
- To stop recording, refer to page 20.
- Changing the [VOLUME] level during recording has no effect on the recorded sound.
- If five seconds elapse after the [REC] button is pressed, the rotating head moves away from the tape to protect the tape. (The REC indicator blinks.)
- A ST-ID is automatically recorded at the start of each tune. (See page 23.)
- When carrying out digital recording from another DAT deck using a tape recorded with ST-IDs and SKIP-IDs, the same sub-codes are recorded on the new tape.

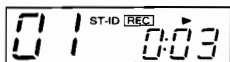
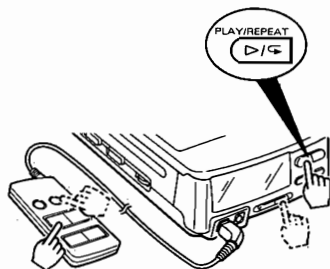

Analog recording

Use the separately sold A/D converter (BP-A7).

First load a tape into the unit (see page 14).

Operation is possible with either the main unit or the remote controller.

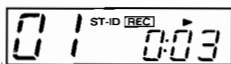
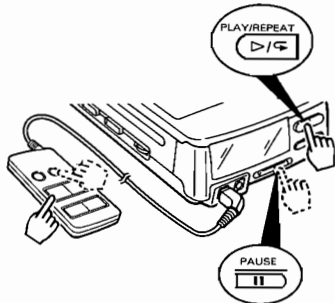
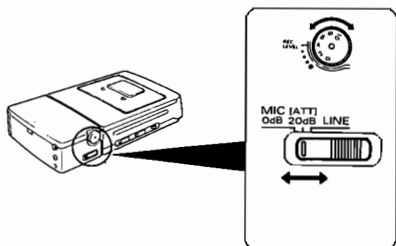
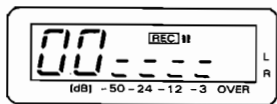
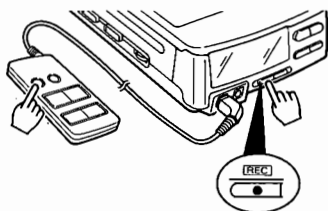

Connect the unit. (See page 13)

Set the [MIC/LINE IN] switch to "LINE" when recording from a LINE input or to "MIC" when recording from a microphone.

- Press the [REC] button.
When starting recording from the beginning of the tape, the unit automatically creates a 5-second blank section and then enters record-standby mode.
- Adjust the recording level using the A/D converter unit.
If the microphone volume is too high, set the "MIC (ATT)" switch to "20 dB".
- Press the [PLAY/REPEAT] button to start recording.
You can also start recording by pressing the [PAUSE] button.
- To stop recording, refer to page 20.
- During record-standby mode, the recording level is displayed.
Set the level so that it does not enter the "OVER" area even when the sound is the loudest.
- When you want to check the recording level, press the [PLAY/REPEAT] button. Press the button again to return to the elapsed time display.
- If the recording level enters the "OVER" area during recording, the time display changes to the recording level display for about one second. If this occurs, lower the recording level slightly.

Stopping/pausing recording

- Operation is possible with either the main unit or the remote controller.



■ To pause recording

- Press the [PAUSE] button.
If five minutes elapse in pause mode, the rotating head moves away from the tape to protect the tape. (The REC indicator blinks.)



■ To stop without recording an END-ID (See page 26)

- Press the [STOP/EJECT] button or press the remote controller's [STOP] button.

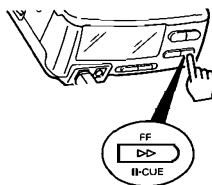

■ To stop after recording an END-ID (See page 26)

- During recording, press the [FF/CUE] button for at least two seconds. (After the END-ID is recorded for nine seconds, the unit enters stop mode.)

■ Erasing a recording

- To erase a tape, set the unit to record mode with nothing connected to the [DIGITAL I/O] jack.
- Do not attach the separately sold A/D converter unit.

Timer recording/Timer playback

- If the timer power turns off while the tape is still running, the tape or rotating head may be damaged.
Set the time period on the timer at least 5 minutes longer than the playback time of the tape.

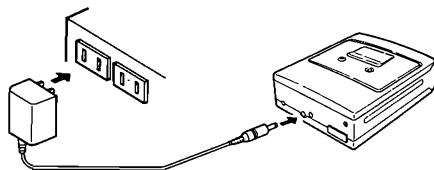

- Before connecting the timer, insert a tape into the unit.
- When carrying out timer recording, make sure the accidental erasure protection "slide door" of cassette tape (page 4) is closed to the right side.

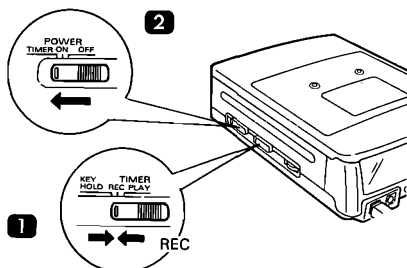

■ Timer recording

- 1 Set the [KEY HOLD/TIMER] switch to "REC", then
- 2 set the [POWER] switch to "TIMER".

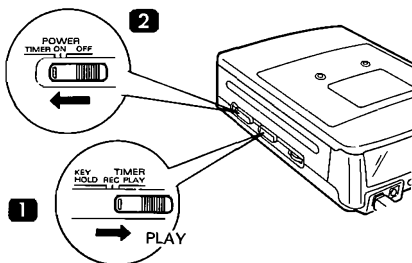

■ Timer playback

- 1 Set the [KEY HOLD/TIMER] switch to "PLAY", then
- 2 set the [POWER] switch to "TIMER".

- When using a timer, make sure the unit is in a location where condensation is unlikely to occur. If condensation forms inside the unit, recording or playback will not start when the set time arrives.
- When carrying out analog recording (page 19), adjust the recording level before connecting the timer.
- When not using a timer, do not set the [POWER] switch to "TIMER", as this will cause recording or playback to start automatically when the AC adaptor is connected.

SCMS

SCMS (Serial Copy Management System)

SCMS is a new standard which allows you to make only first generation copies of digital sources (CD, etc.) which contain a copy prohibition code.

Copy prohibition code

Sources which contain a copy prohibition code include the following: CDs and some commercially available DAT music tapes.

When carrying out analog recording

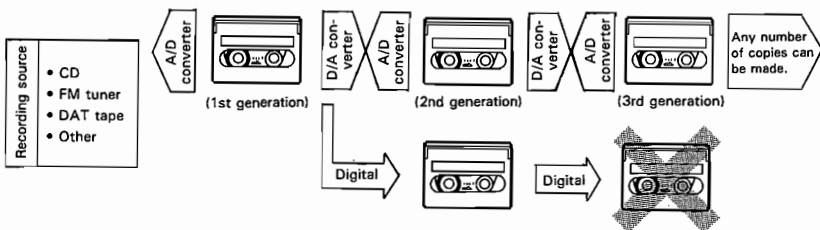

When carrying out digital recording

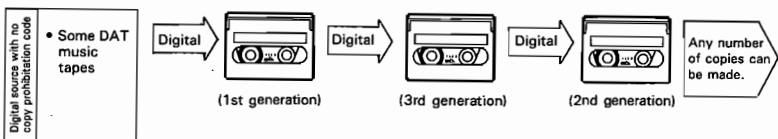
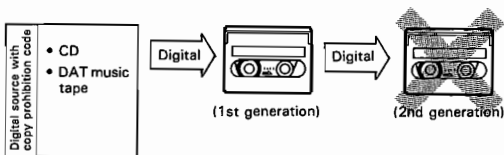

- There are some cases where the above rules do not apply, such as with DAT music tapes which do not follow the SCMS standard.

Subcodes

With DAT tapes, in addition to the recorded music signal, various subcodes are recorded on the tape to aid in music selection and editing.

With commercially available DAT music tapes, subcodes are prerecorded on the tapes. With blank tapes that you record yourself, subcodes are automatically recorded during recording and can also be recorded manually during editing.

■ ST-ID (Start ID)

This signal is recorded at the beginning of each tune. By searching for this signal, the unit can locate the beginning of a designated tune.

Also, the tune number for each tune is written on the tape at the same position as the ST-ID. Therefore, if the ST-ID is not written at the proper position, the tune number will not be displayed correctly.

- The ST-ID is automatically written on the tape during recording in the following cases:
 1. When sound is detected again after a blank section of 2 seconds or longer occurs during recording.
 2. When recording starts and sound is detected after recording was stopped or paused.
- Depending on the contents of the source being recorded, ST-IDs may not be written correctly on the tape (in cases such as when there is excessive noise between tunes, when the interval between tunes is short, when the sound stops and then starts again in the middle of a tune, or when a tune contains a section of extremely low level sound). In such cases, you will need to edit the subcodes later. (See page 24.)

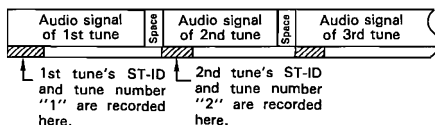

- **A ST-ID cannot be written within 9 seconds after the previous ST-ID.**

■ END-ID

This signal is recorded to indicate the end of the recorded contents. The unit stops automatically when this signal is detected during playback or fast-forwarding.

This signal is also handy for quickly locating the end of a recording when continuing a recording from the end of the previously recorded contents.

- If recording is continued from the end of a previous recording that has no END-ID, the total elapsed time may not continue into the newly recorded section. In such a case, the total elapsed time for the newly recorded section will not be displayed and the tune search function may not operate correctly. Always write an END-ID at the end of a recording.

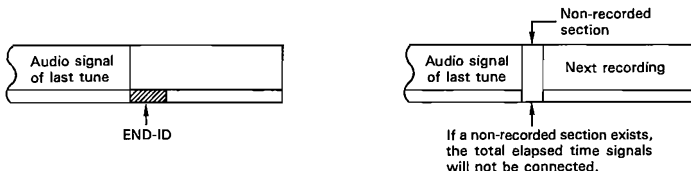

- **Make sure there is at least 9 seconds between the last ST-ID and the END-ID.**

Subcode editing

■ To manually write a ST-ID during recording

- In situations such as when recording an audio source that has no space between tunes, you can manually write ST-IDs in the appropriate locations while recording is being carried out.

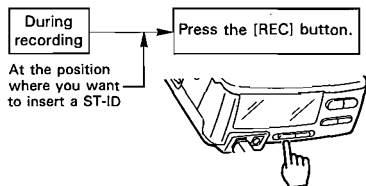

- After writing a ST-ID, you must wait at least 9 seconds before writing the next ST-ID.
- You cannot write more than 99 tune numbers.
- If no tune number is displayed, writing a ST-ID will not switch to the next tune number. Renumber the tunes after recording is finished. (See page 25.)

■ To add a ST-ID to a previously recorded tape

- If the displayed tune number does not change when tunes change during playback, no ST-ID is recorded at that location. In such a case, use the following procedure to add the necessary ST-ID.

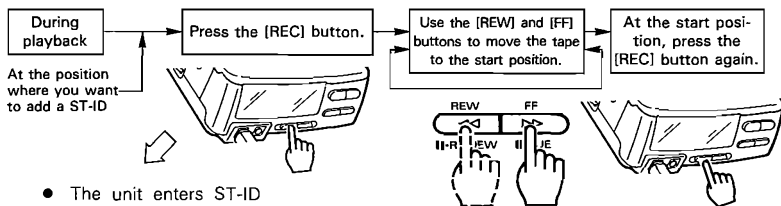

- The unit enters ST-ID record-standby mode and the following operation occurs.
- After three seconds of playback, the tape automatically rewinds to a position two seconds before the start position. (This is repeated up to 10 times.)
- Each time one of these buttons is pressed, the position where the ST-ID indicator lights is moved forward or backward by 0.3 second. (1.8 seconds max.)
- The ST-ID is written on the tape and then playback continues.

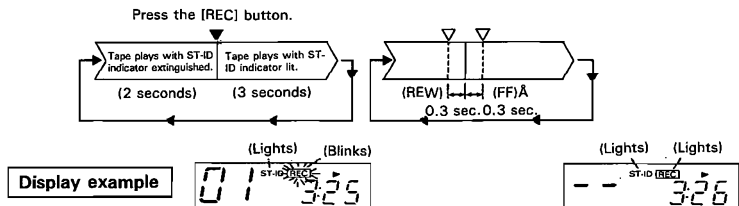

- Leave at least 9 seconds between ST-IDs.
- Tune numbers do not change automatically when a ST-ID is added. After adding all necessary ST-IDs, renumber the tunes. (See page 25.)

■ To erase an unnecessary ST-ID from a recorded tape

- If the tune number changes at a place other than between two tunes, an unnecessary ST-ID is written on the tape.

Erase the ST-ID using the following procedure.

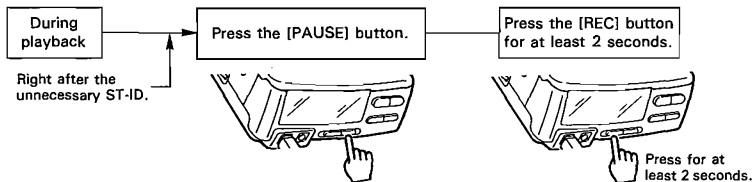

- The unit enters pause mode after the unnecessary ST-ID.

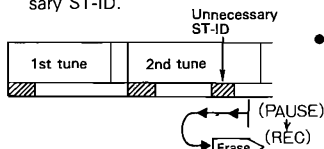

- The tape automatically rewinds to the beginning of the unnecessary ST-ID.
- The ST-ID is erased and then playback continues.

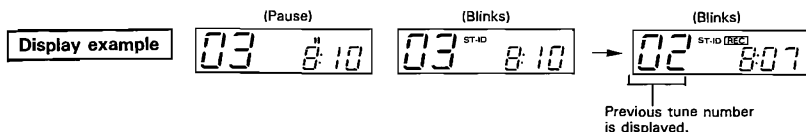

■ Renumbering tunes

- After adding or deleting one or more ST-IDs, you should renumber the tunes so that the tune numbers run consecutively from the first to the last tune starting with "1".

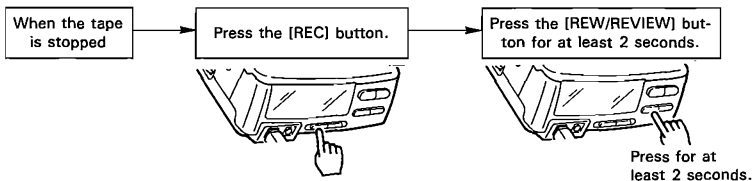

- The unit enters record-standby mode.

(Record-standby)

Display example

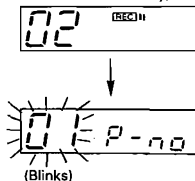

- The tape automatically rewinds to the beginning and then fast-forwards to renumber all the tunes.
- The tape automatically rewinds to the beginning again and stops.

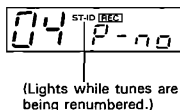

■ To write an END-ID on a recorded tape

- If a tape was stopped at the end of a recording without writing an END-ID, you can use the following procedure to write the necessary END-ID.

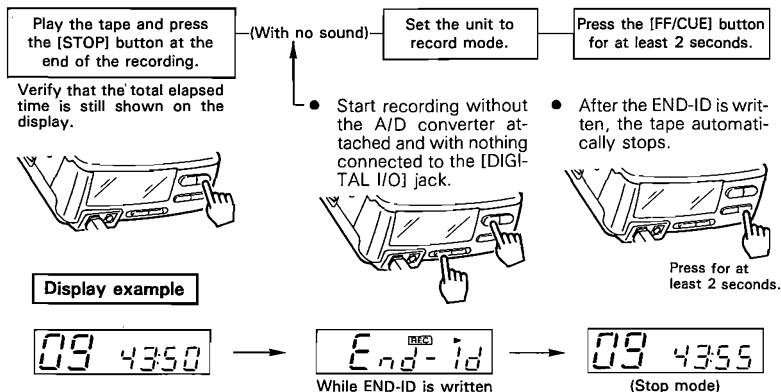

- Leave at least 9 seconds between the last ST-ID and the END-ID.

■ To continue recording from the END-ID position

- When you want to continue recording on a tape which contains an END-ID, you can use the following procedure to continue the recording without interruption.

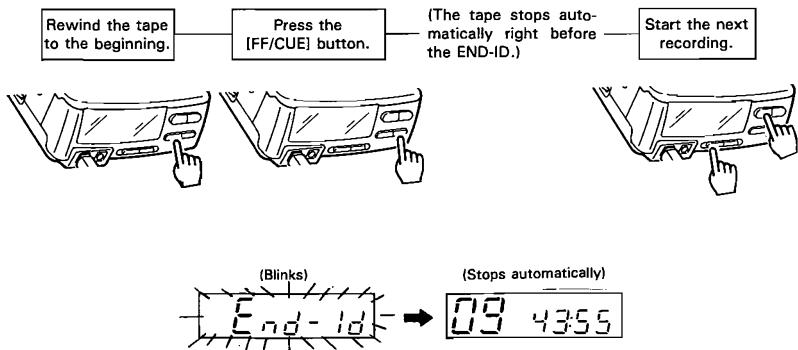

- If the next recording is started using this procedure, the END-ID is erased automatically. Tune numbers are automatically continued in sequence, and the total elapsed time is automatically continued from the previous recording.

Cleaning

- **Cleaning the cabinet**

Clean the cabinet by wiping with a dry cloth. If an area is particularly dirty and cannot be cleaned well with a dry cloth, wipe the area with a cloth dampened with water, then wipe dry with a dry cloth. (Do not use benzene, thinner, or other chemicals.)

Always keep terminals and plugs clean.

- **Cleaning the head**

If the head becomes dirty or covered with dust, sound dropouts or noise may occur.

Also, if the head becomes clogged during playback, "Error" will appear on the display and the sound will stop.

In such cases, clean the head with a commercially available DAT-use head cleaning tape.

- Do not inject oil into the unit. This will damage the unit.

If the head becomes worn after long use, it must be replaced. Contact your dealer for the replacement (fee required).

- "Error" may appear on the display if a wrinkled or damaged tape is used or if the head becomes clogged. If this occurs, replace the tape or try cleaning the head with a cleaning tape.

- If this unit is subjected to a strong external disturbance (such as a shock or abnormal voltage) or misoperation, the unit may stop responding to button operations or operate abnormally.

In such a case, disconnect the AC adaptor plug, wait about 30 seconds, reconnect the plug, then retry the operation.

■ Accessories

(1) Remote controller



(2) AC adaptor

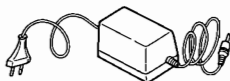

(3) Digital connection Cord



(4) Analog connection cord



(5) Digital-use adaptor plug



(6) Plug adaptor (Except for USA, Canada and UK)



Specifications

1

Tape recording system	DAT rotating head system
Tape speed	8.15 mm/sec
Sampling frequency	48 kHz/44.1 kHz/32 kHz
No. of quantization bits	16 bits, linear
Frequency response	5~22,000 Hz (EIAJ) (for digital recording)
Signal-to-noise ratio	90 dB or greater (EIAJ)
Dynamic range	90 dB or greater (EIAJ)
Wow and flutter	Below measurable limit (EIAJ)
Digital I/O terminal	Coaxial: 3.5 mm diameter 4-pin minijack
Analog output terminal	Headphone: 3.5 mm diameter stereo minijack
Other terminals	External power supply input: (DC6V) × 1 Terminal for connecting separately sold A/D converter BP-A7
Battery life (continuous use)	Approx. 1.5 hours (EIAJ) during playback (when connected to separately sold A/D converter BP-A7)
Power supply	6V DC: External DC IN jack 120V AC, 50/60 Hz: USA and Canada, using the supplied AC adaptor 110V-120V/220V-240V AC, 50/60 Hz: All other countries, using the supplied AC adaptor
Dimensions (main unit)	91.0 (W) × 34.9 (H) × 121.5 (D) mm
Max. external dimensions (EIAJ, including projections)	91.7 (W) × 36.2 (H) × 121.9 (D) mm
Weight	Approx. 420 gr (main unit)

Note:

We follow a policy of continuous advancements in development. For this reason specifications may be changed without notice.
